

HAVANNA

TRAMPOLINE

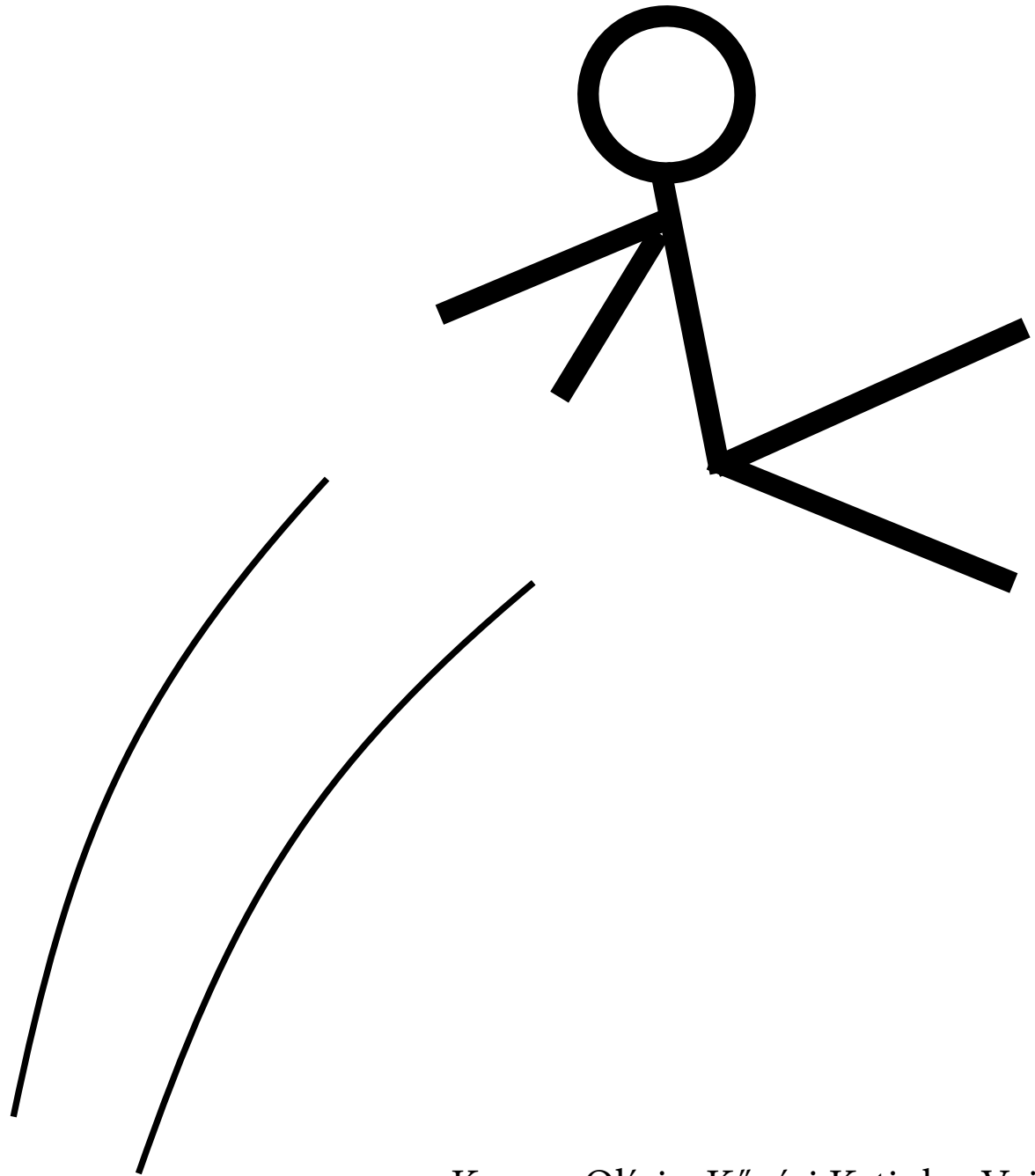

Kurucz Olívia, Kővári Katinka, Vojtěch Bis

PRINCIPLE

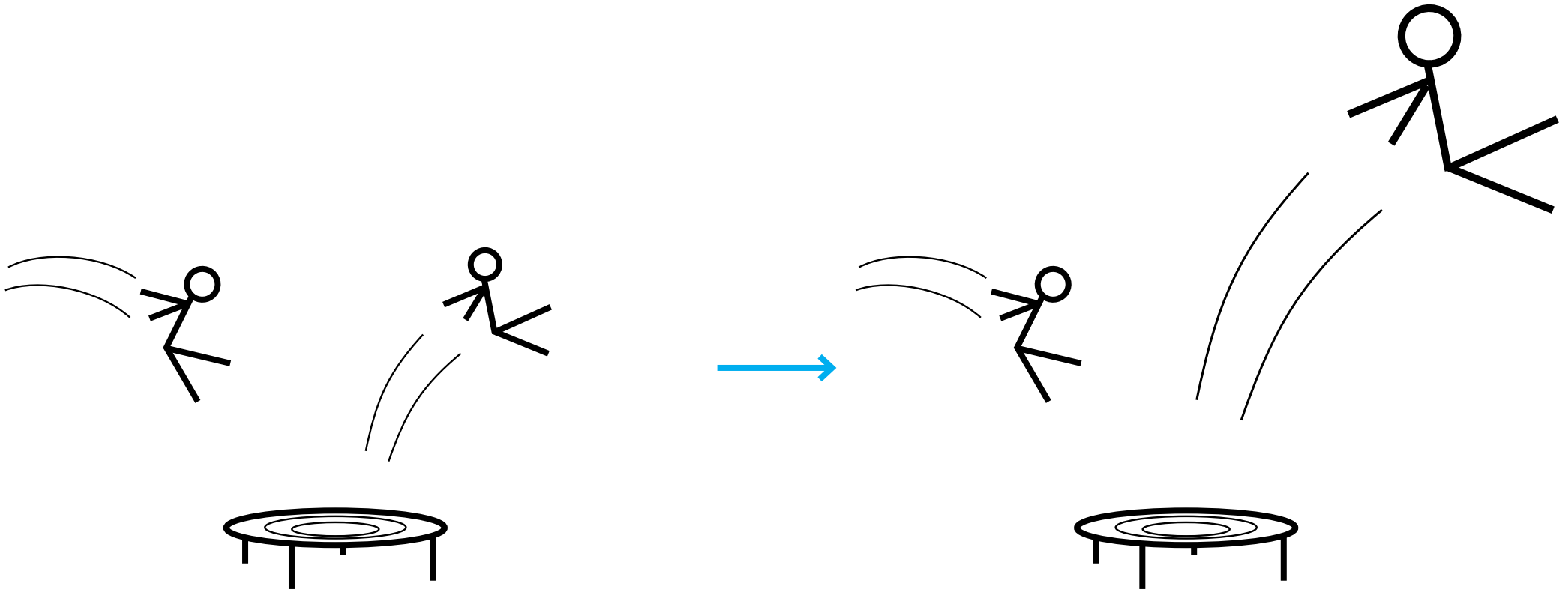

WHO ARE THE [USERS?](#)

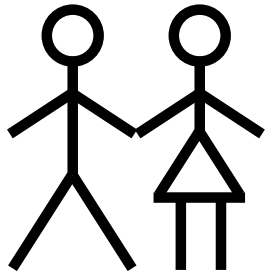

young couples

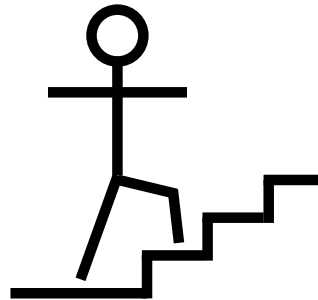

career starters

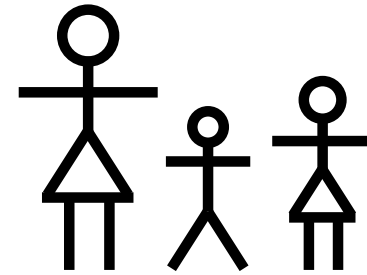

single mothers

WHAT CAN WE OFFER?



FUNCTIONS

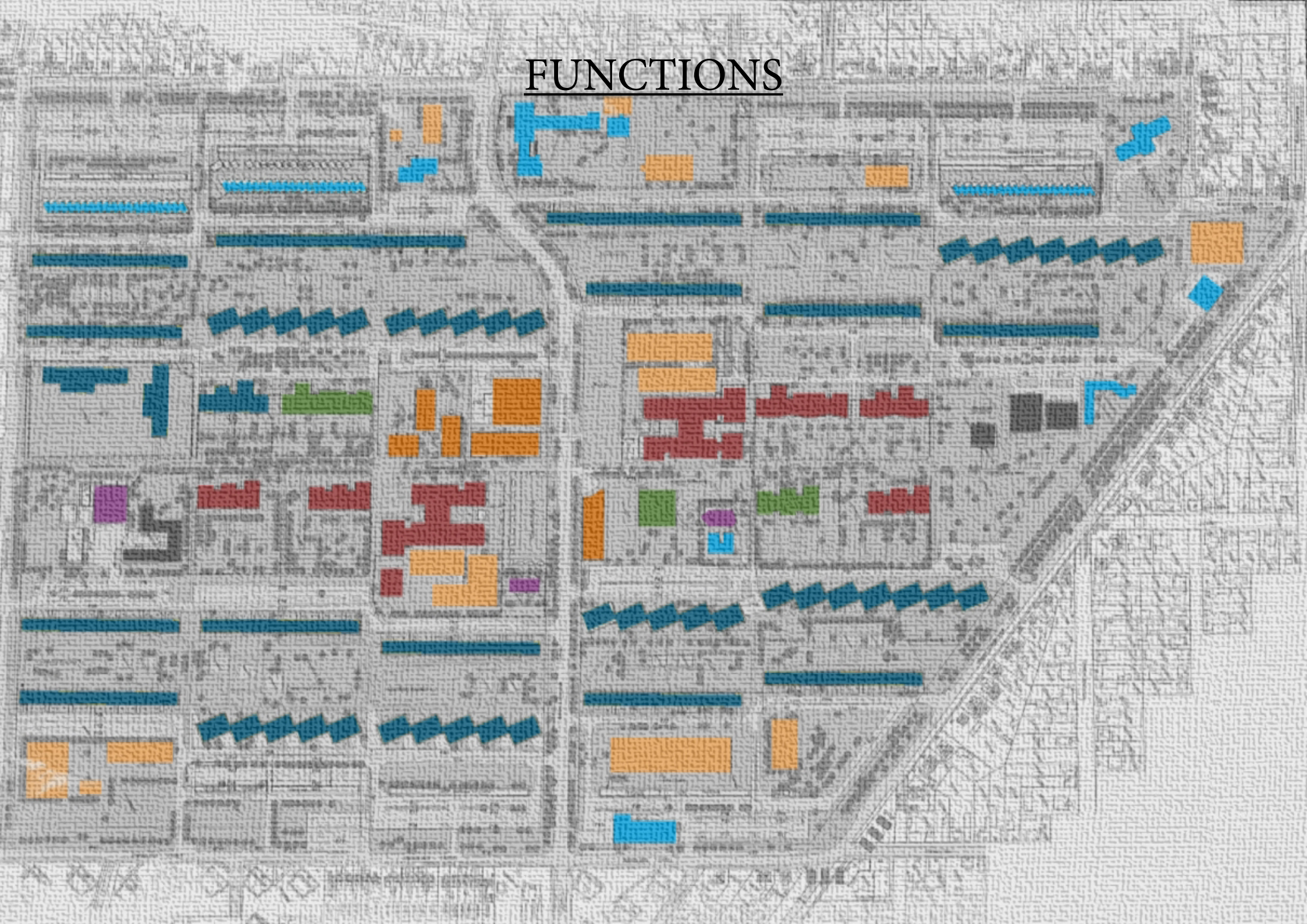

REPLACING

IMPROVING

REPLACING

IMPROVING

REPLACING

DEMOLITIONS

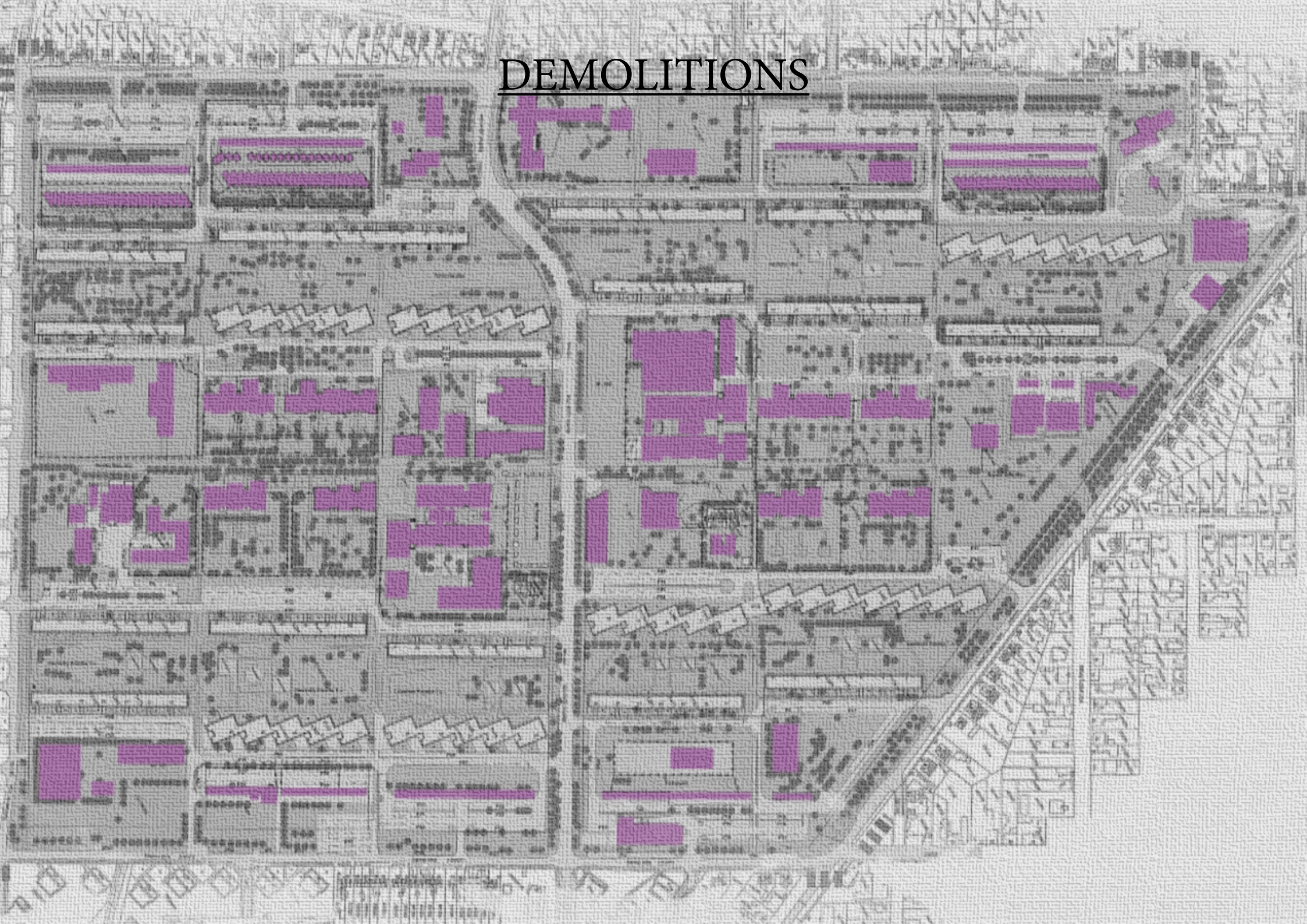

PROPOSAL

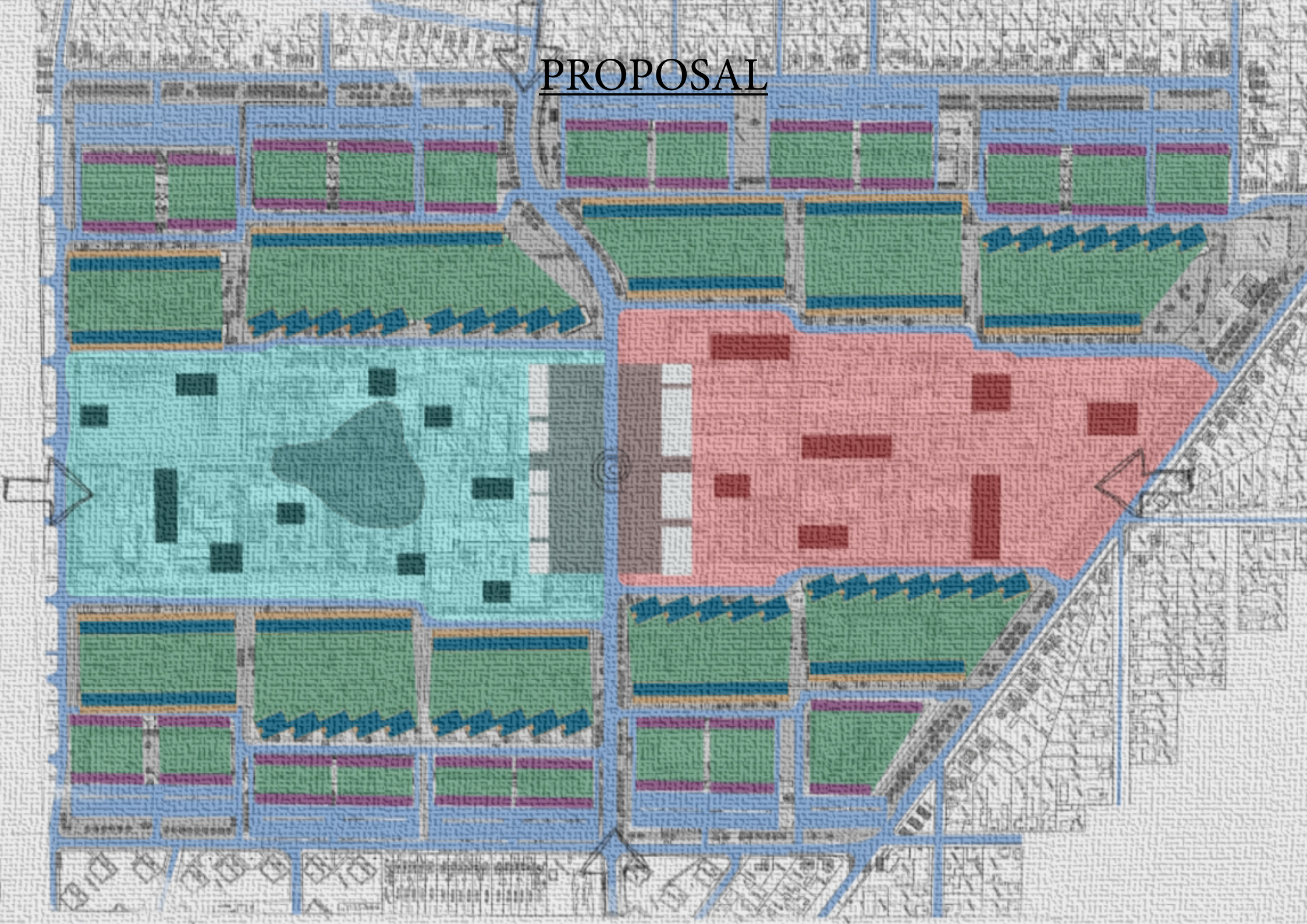

SECTIONS

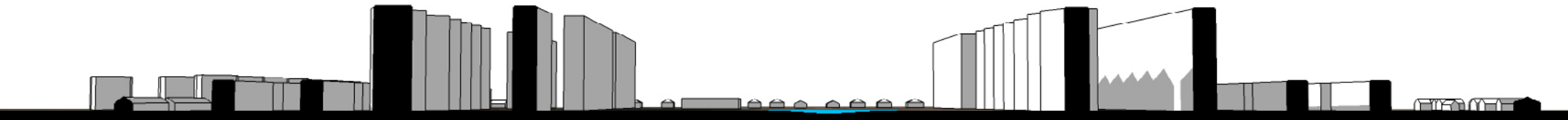

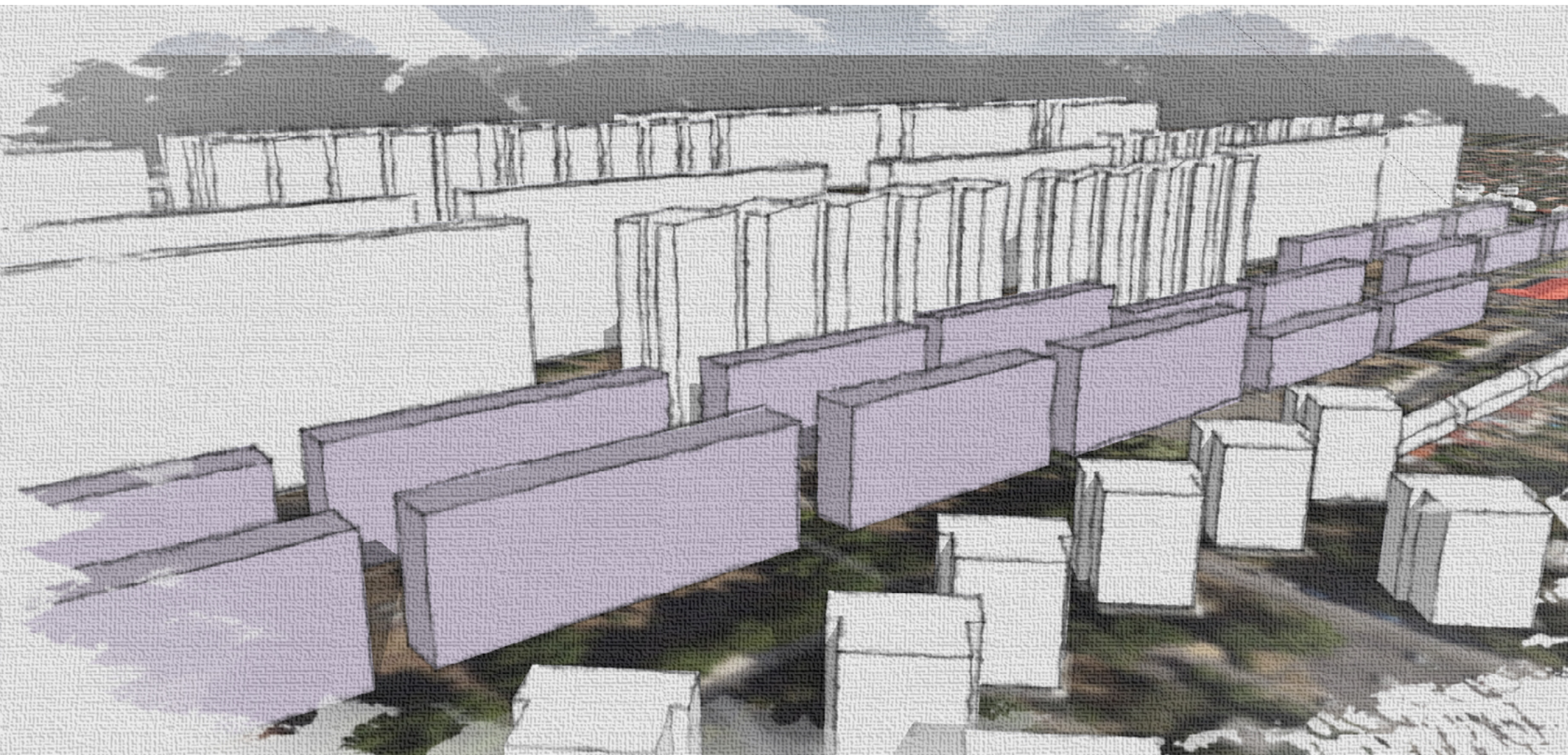

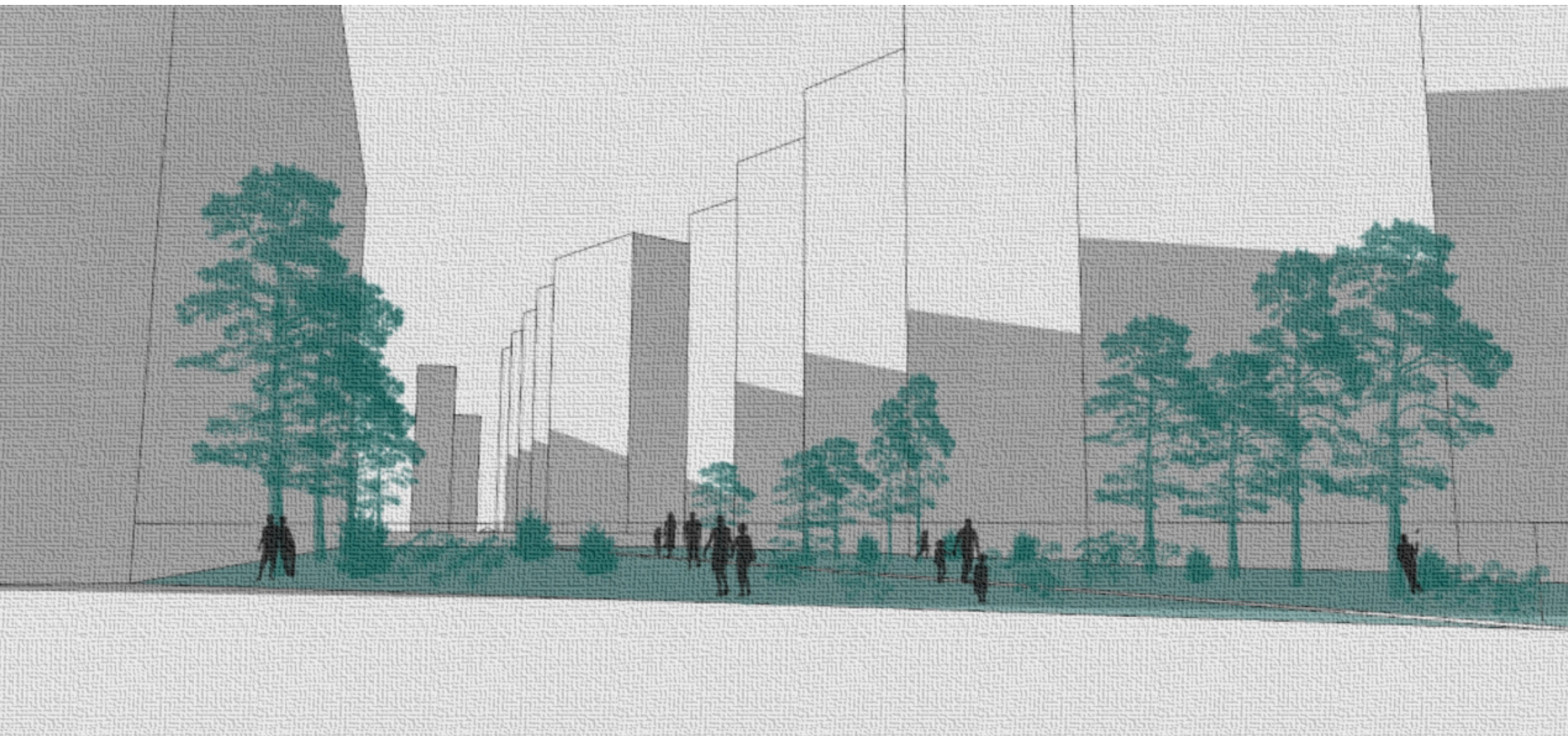

CLEAR BORDERS BETWEEN
PUBLIC AND (SEMI)PUBLIC

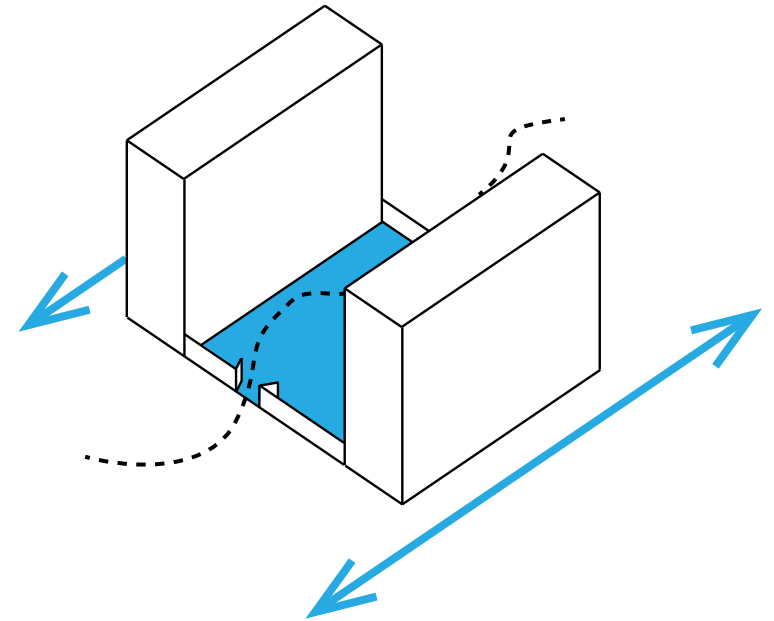
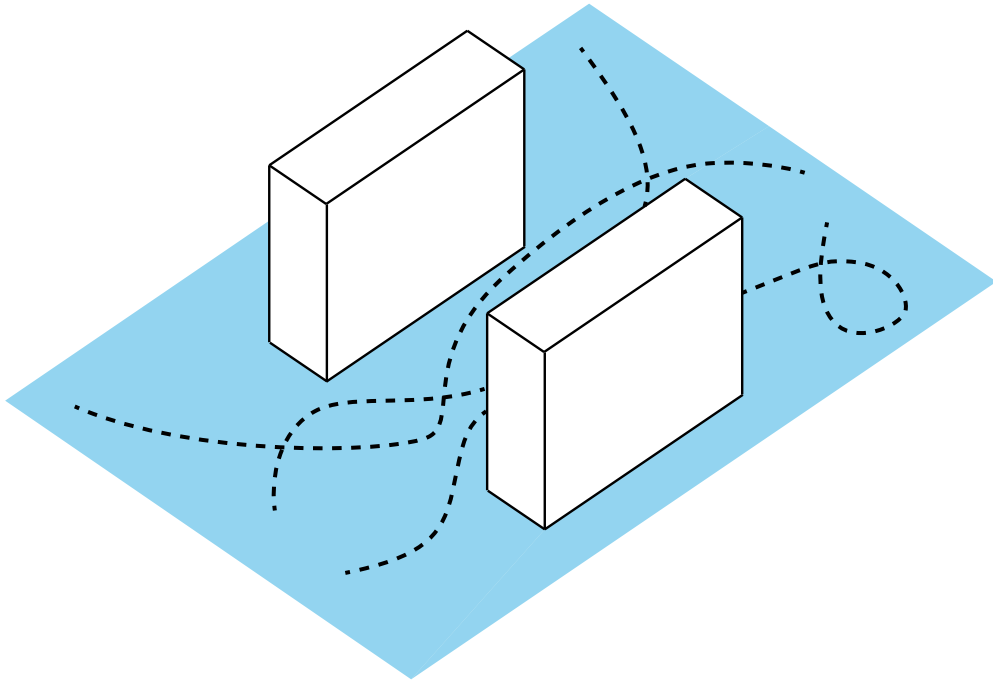

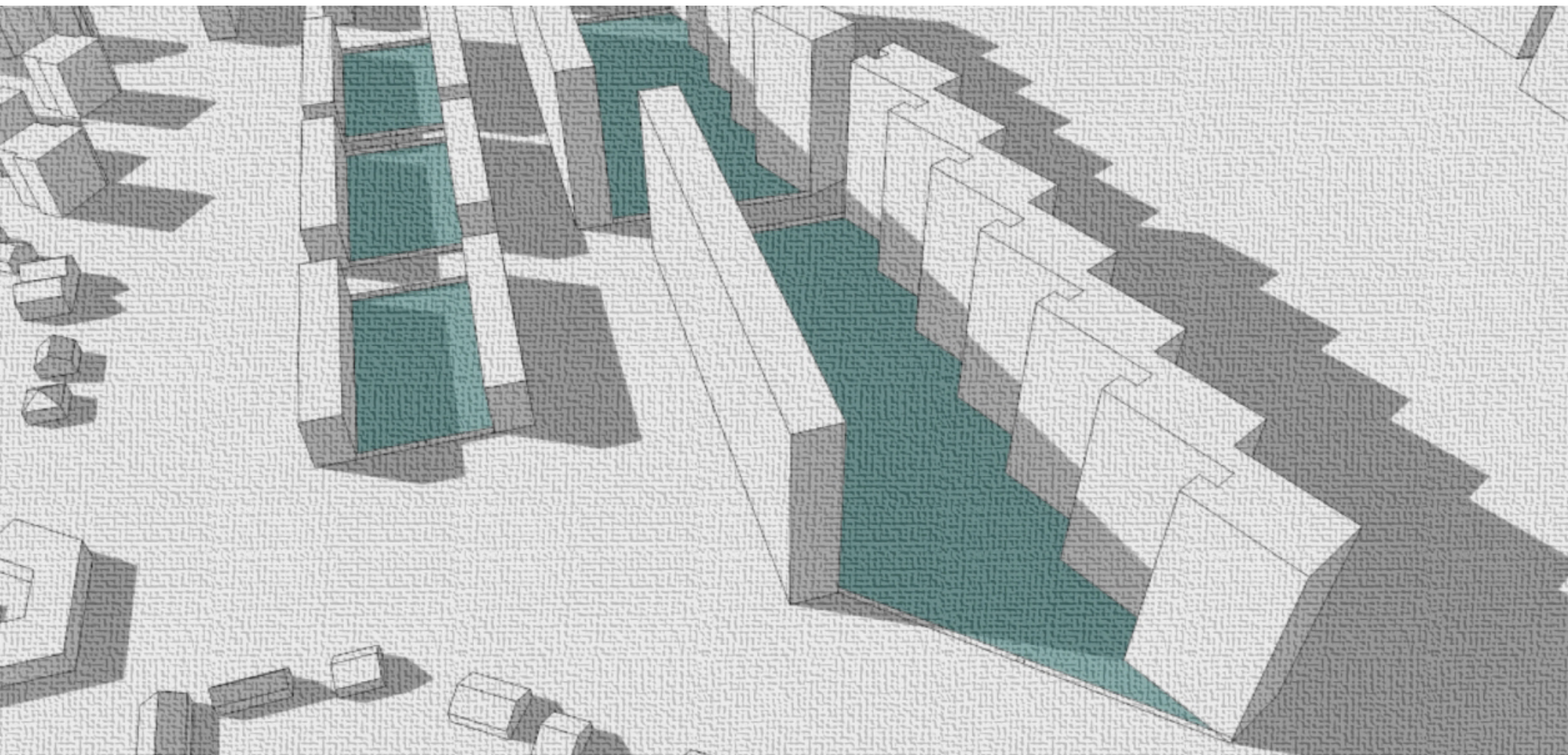

PROCES

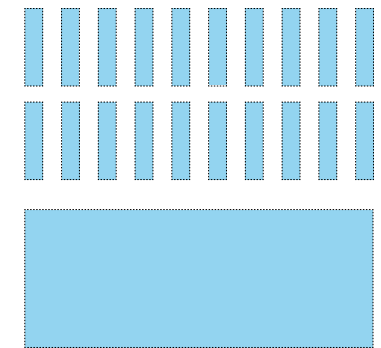
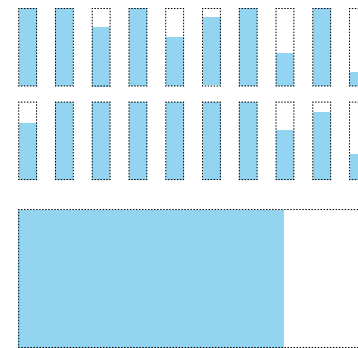
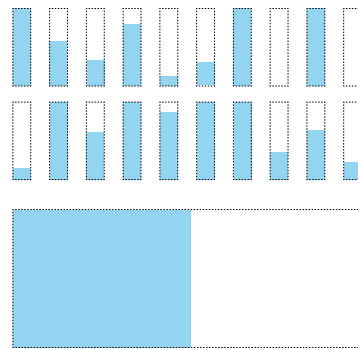
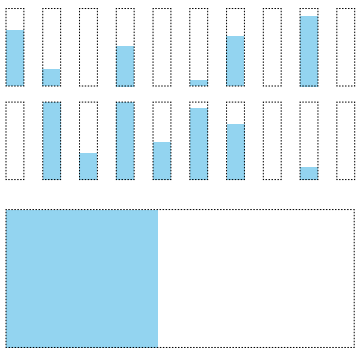
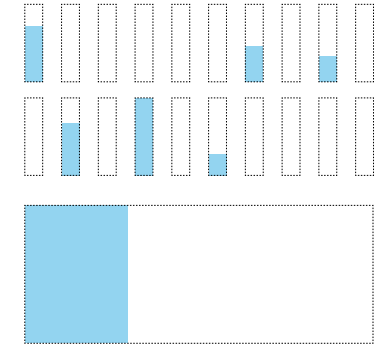
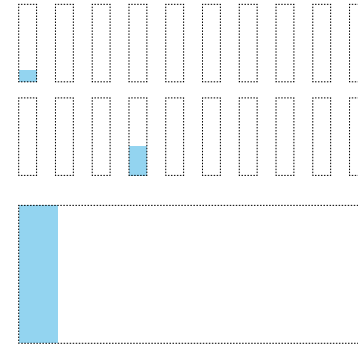
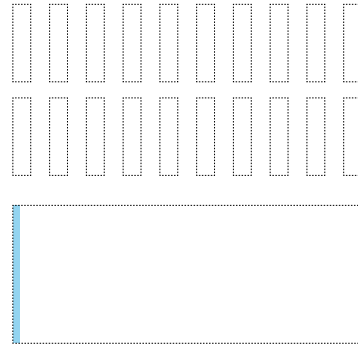
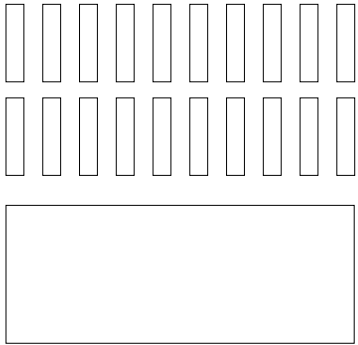

Thank you for your attention.